

Article number: 03487030
 Description: Fluro Rod end EAL 30D-2RS
 Note: 30

Measures

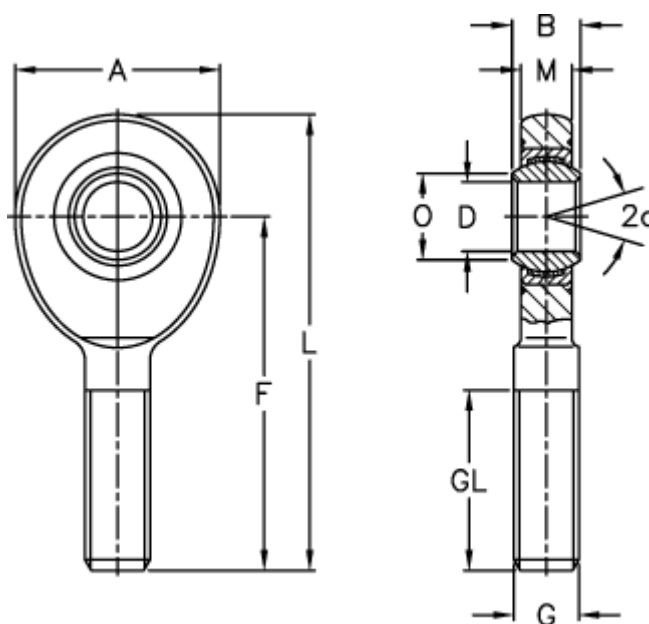

A	= 73	L	= 146.5
a (degrees)	= 6	M	= 19
B	= 22	O	= 34.2
D	= 30	Static drive kN	= 124
Dynamic drive (kN)	= 66	Weight	= 890
F	= 110		
g	= M 30x2		
GL	= 65		